



SPIRIT OF GAMER

UK /LED connection guide

FR /Guide de branchement LED

DE /LED-Anschlussanleitung

IT /Guida al collegamento dei LED

ES /Guía de conexión de los LED

ARGB Hub-A :

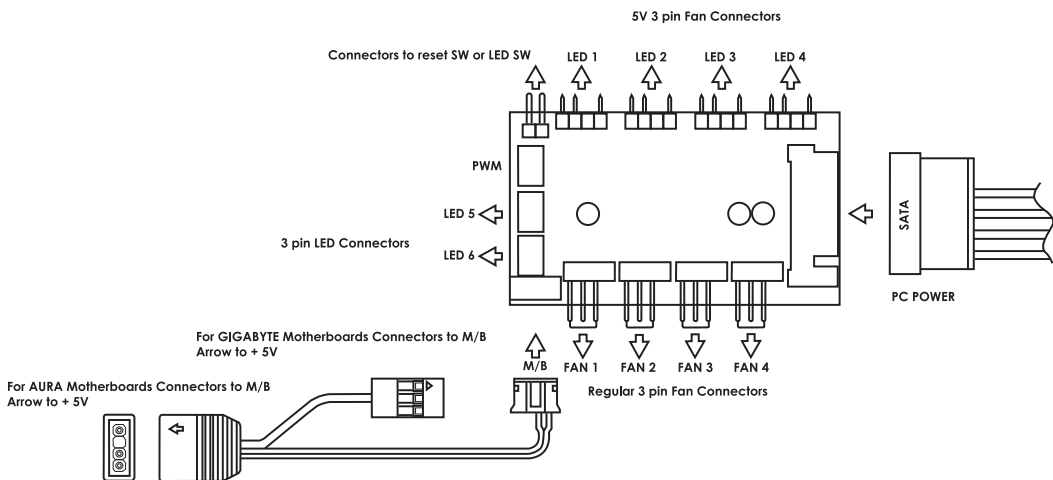

ARGB Hub-B :

For Motherboards Connectors to FAN PWM (optional)



For GIGABYTE Motherboards Connectors to M/B Arrow to 5V

For AURA Motherboards Connectors to M/B Arrow to 5V

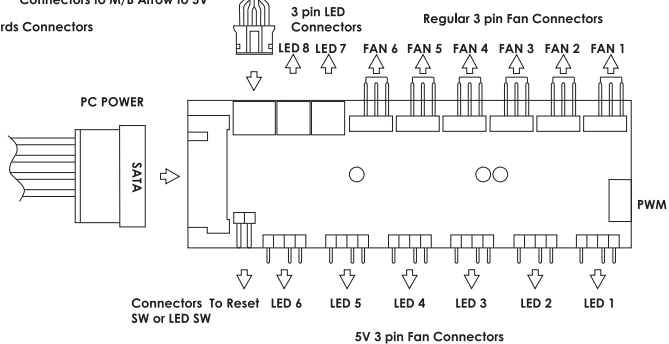

Specification:

- 6 port (ARGB HUB-B) or 4 port (ARGB HUB-A) x 5V 3 pin connector of fan
- 6 port (ARGB HUB-B) or 4 port (ARGB HUB-A) x regular 3 pin connector of fan
- 2 port x 3 pin connector of LED strip
- 1 port x PWM (ARGB HUB-B)
- 1 port x 5V 3pin connect to M/B
- 1 port x SATA connect to power supply
- 1 port x 2 pin connect to LED switch

Function:

1. Manual control by pressing LED button
2. Press LED button for 3 seconds change mode to motherboard control
3. Press LED button for 5 seconds to turn off LED power
4. Press LED button back to manual control by LED button
5. Support PWM (ARGB HUB-B)
6. Up to 6 pcs (ARGB HUB-B) or 4 pcs (ARGB HUB-A) of ARGB fan, 2 pcs of LED strip to be connected
7. With memory function
8. Random effect from the first start

How to use manual control:

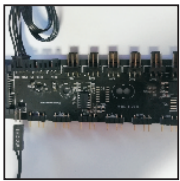

STEP 1
Connect reset switch/led switch to 2 pin connector.

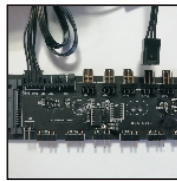

STEP 2
Connect regular fan 3 pin to regular fan connector

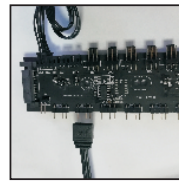

STEP 3
connect 5V 3pin to 5V 3 pin connector



STEP 4
Connect 3 pin ARGB trip to led connector

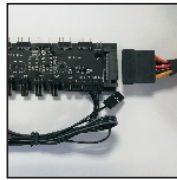

STEP 5
Connect SATA connector



STEP 6
Start manual control by pressing Reset/LED button

How to use AURA adapter to control by motherboard:



STEP 1
Please make sure the motherboard has 5V addressable RGB header.



STEP 2
Find AURA adapter from ARGB hub.

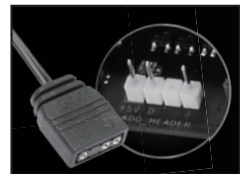

STEP 3
Connect AURA adapter (5V addressable 3 pin) from hub to 5V addressable RGB header from motherboard.

STEP 4
Get AURA software from motherboard official website and install it to your computer (please make sure you already install AURA software to your computer before you connect AURA adapter to 5V addressable RGB header from motherboard then activate AURA system. There's an activation indicator in upper left corner or somewhere, it will be also depends on different motherboard.)

STEP 5
Press manual button on front panel for 3 seconds to switch to motherboard control, and press manual button for 1 second to switch back to manually control.

STEP 6
Choose different color effects from AURA system after you switch it to motherboard control mode.

ARGB Hub-A :

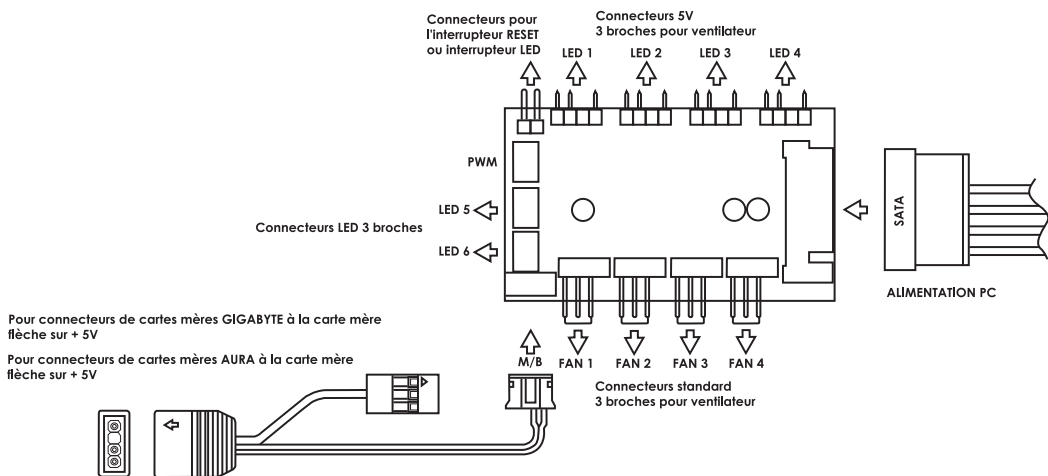

ARGB Hub-B :

Pour connecteurs de cartes mères au VENTILATEUR PWM (en option)

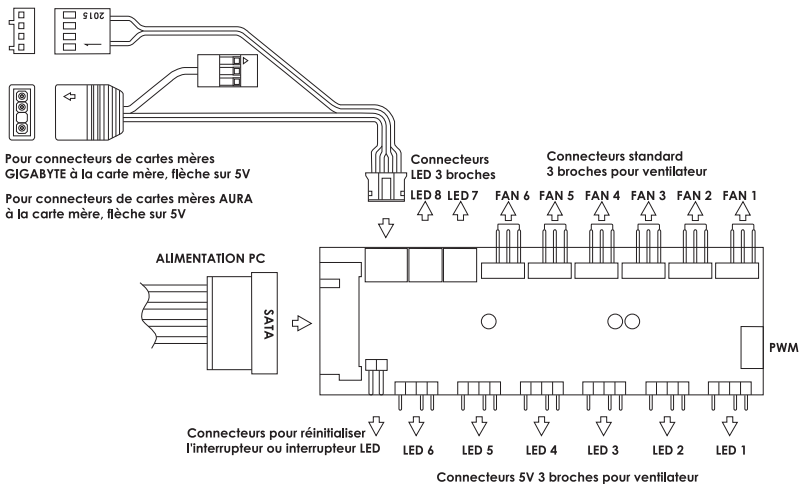

Caractéristiques techniques :

- 6 ports (HUB-B ARGB) ou 4 ports (HUB-A ARGB) x connecteur 5V 3 broches du ventilateur
- 6 ports (HUB-B ARGB) ou 4 ports (HUB-A ARGB) x connecteur standard 3 broches du ventilateur
- 2 ports x connecteur 3 broches de bande LED
- 1 port x PWM (HUB-B ARGB)
- 1 port x connexion 5V 3 broches à la carte mère
- 1 port x connexion SATA à l'alimentation électrique
- 1 port x connexion 2 broches à l'interrupteur LED

Fonction :

1. Contrôle manuel en appuyant sur le bouton LED
2. Appuyer sur le bouton LED pendant 3 secondes pour passer en mode contrôle par la carte mère
3. Appuyer sur le bouton LED pendant 5 secondes pour couper l'alimentation LED
4. Appuyer à nouveau sur le bouton LED pour revenir au contrôle manuel par le bouton LED
5. Support PWM (HUB-B ARGB)
6. Jusqu'à 6 pcs (ARGB HUB-B) ou 4 pcs (HUB-A ARGB) du ventilateur ARGB, 2 pcs de bande LED à raccorder
7. Avec fonction mémoire
8. Effet aléatoire dès le premier démarrage

Comment utiliser le contrôle manuel :

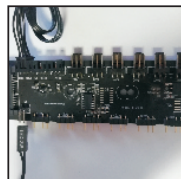

ÉTAPE 1

Branchez l'interrupteur de réinitialisation/l'interrupteur led sur le connecteur 2 broches.

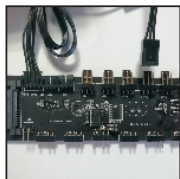

ÉTAPE 2

Branchez le ventilateur standard 3 broches sur le connecteur standard du ventilateur.

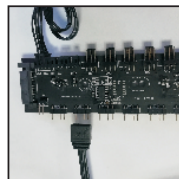

ÉTAPE 3

Branchez 5V 3 broches sur le connecteur 5V 3 broches.

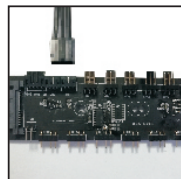

ÉTAPE 4

Branchez la bande ARGB 3 broches sur le connecteur led.

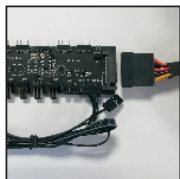

ÉTAPE 5

Branchez le connecteur SATA.



ÉTAPE 6

Démarrez le contrôle manuel en appuyant sur le bouton Reset/LED.

Comment utiliser l'adaptateur AURA pour un contrôle par la carte mère :



ÉTAPE 1

Assurez-vous que la carte mère dispose d'une embase RGB 5V adressable.

ÉTAPE 4

Procurez-vous le logiciel AURA sur le site internet officiel de la carte mère et installez-le sur votre ordinateur (assurez-vous d'avoir déjà installé le logiciel AURA sur votre ordinateur avant de brancher l'adaptateur AURA sur l'embase RGB 5V adressable de la carte mère puis activez le système AURA. Un indicateur d'activation se trouve en haut à gauche, ou quelque part, cela dépend aussi de la carte mère.)

ÉTAPE 5

Appuyez sur le bouton manuel de la face avant pendant 3 secondes pour passer au contrôle par la carte mère, et appuyez sur le bouton manuel pendant 1 seconde pour revenir au contrôle manuel.

ÉTAPE 6

Une fois en mode contrôle par la carte mère, choisissez différents effets de couleur dans le système AURA.



ÉTAPE 2

Trouvez l'adaptateur AURA du hub ARGB.



ÉTAPE 3

Branchez l'adaptateur AURA (5V, 3 broches, adressable) du hub sur l'embase RGB 5V adressable de la carte mère.

ARGB Hub-A :

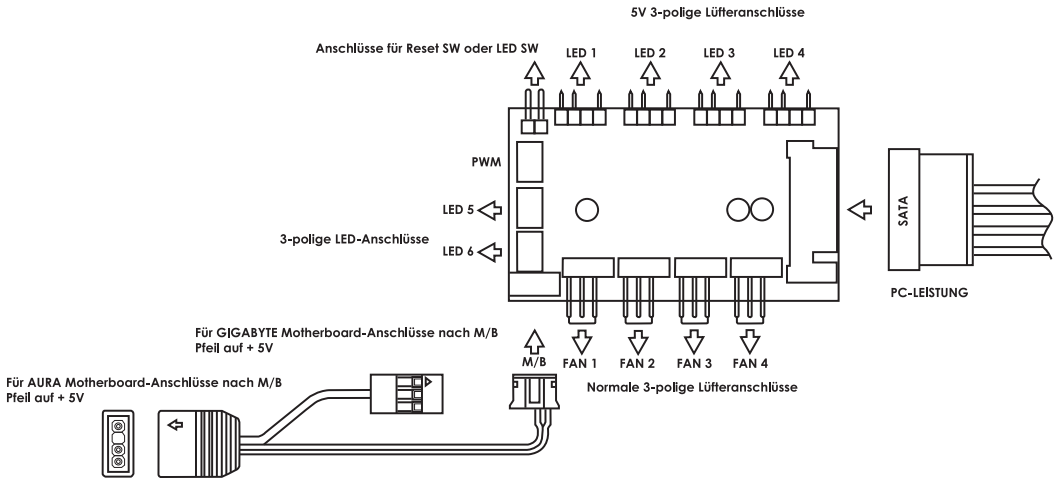

ARGB Hub-B :

Für Motherboard-Anschlüsse zum LÜFTER PWM (optional)

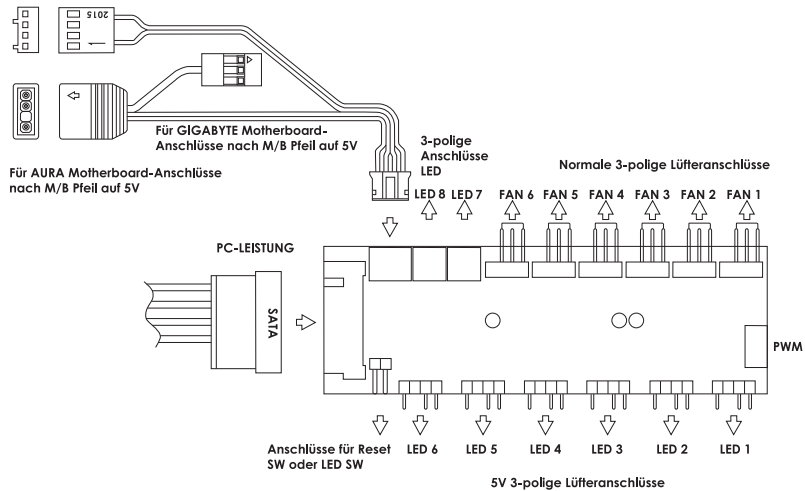

Spezifikation:

- 6 Anschlüsse (ARGB HUB-B) oder 4 Anschlüsse (ARGB HUB-A) x 5V 3-poliger Lüfteranschluss
- 6 Anschlüsse (ARGB HUB-B) oder 4 Anschlüsse (ARGB HUB-A) x normaler 3-poliger Lüfteranschluss
- 2 Anschlüsse x 3-poliger LED-Streifen-Anschluss
- 1 Anschluss x PWM (ARGB HUB-B)
- 1 Anschluss x 5V 3-poliger Anschluss an M/B
- 1 Anschluss x SATA-Anschluss an Netzteil
- 1 Anschluss x 2-poliger Anschluss an LED-Schalter

Funktion:

1. Manuelle Steuerung durch Betätigung der LED-Taste
2. Drücken Sie 3 Sekunden lang auf die LED-Taste, um den Modus der Motherboard-Steuerung abzuändern
3. Drücken Sie 5 Sekunden lang auf LED-Taste, um die LED-Leistung abzuschalten
4. Drücken Sie auf die LED-Taste, um zurück zur manuellen Steuerung durch LED-Taste zu gelangen
5. Support PWM (ARGB HUB-B)
6. Bis zu 6 St. (ARGB HUB-B) oder 4 St. (ARGB HUB-A) ARGB-Lüfter, 2 St. LED-Streifen zum Anschließen
7. Mit Speicherfunktion
8. Zufallseffekt von Anfang an

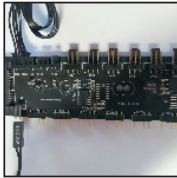
Wie die manuelle Steuerung verwenden:**SCHRITT 1**

Schließen Sie den Reset-/LED-Schalter an 2-poligen Steckverbinder an.

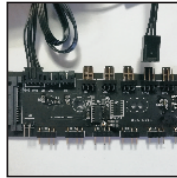
**SCHRITT 2**

Schließen Sie den normalen 3-poligen Lüfter an normalen Lüfteranschluss an.

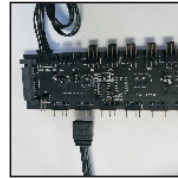
**SCHRITT 3**

Schließen Sie den 3-poligen 5V an 3-poligen 5V Stecker an.

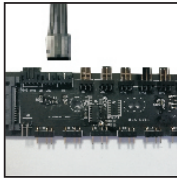
**SCHRITT 4**

Schließen Sie den 3-poligen ARGB Trip an LED-Stecker an.

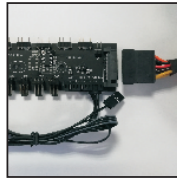
**SCHRITT 5**

Schließen Sie den SATA-Anschluss an.

**SCHRITT 6**

Starten Sie die manuelle Steuerung durch Betätigung der Reset/LED-Taste.

Wie den AURA-Adapter zur Steuerung durch Motherboard verwenden:**SCHRITT 1**

Stellen Sie bitte sicher, dass das Motherboard über 5V adressierbare RGB-Header verfügt.

**SCHRITT 2**

Suchen Sie den AURA-Adapter vom ARGB-Hub.

**SCHRITT 3**

Schließen Sie den AURA-Adapter (5V adressierbar 3-polig) vom Hub an 5V adressierbaren RGB-Header vom Motherboard an.

SCHRITT 4

Beziehen Sie die AURA-Software von der offiziellen Motherboard-Website und installieren Sie sie auf Ihrem Computer (vergewissern Sie sich bitte, dass Sie bereits die AURA-Software auf Ihrem Computer installiert haben, bevor Sie den AURA-Adapter an den 5V adressierbaren RGB-Header vom Motherboard anschließen, aktivieren Sie dann das AURA-System. In der oberen linken Ecke oder an einer anderen Stelle (je nach Motherboard) gibt es eine Aktivierungsanzeige.

SCHRITT 5

Betätigen Sie 3 Sekunden lang die Schaltfläche manuell auf der Frontplatte, um die Motherboard-Steuerung anzuschalten und betätigen Sie die Schaltfläche manuell 1 Sekunde lang, um in die manuelle Steuerung zurückzukehren.

SCHRITT 6

Wählen Sie verschiedene Farbeffekte vom AURA-System aus, nachdem Sie in den Motherboard-Steuermodus geschaltet haben.



ARGB Hub-A :

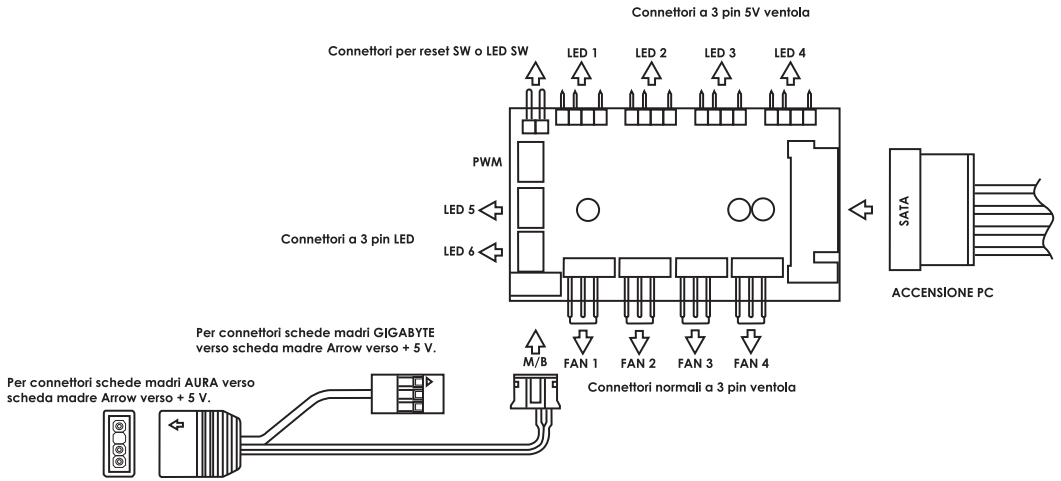

ARGB Hub-B :

Per connettori schede madri verso VENTOLA PWM (opzionale)

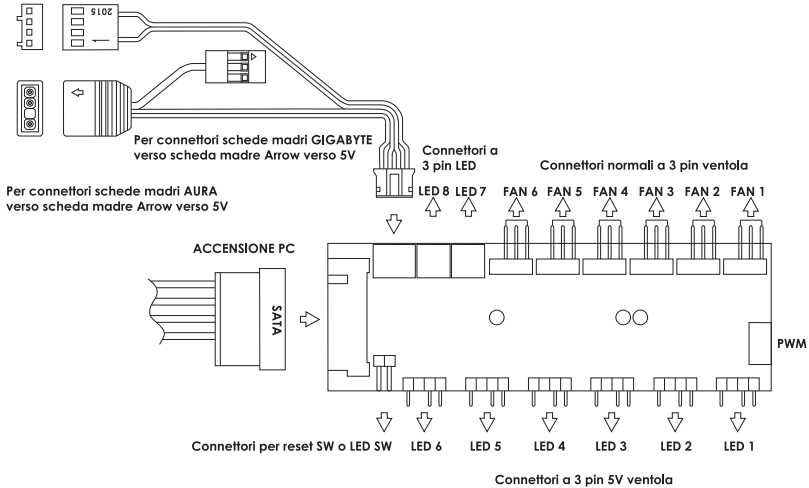



Specifiche:

- 6 porte (HUB-B ARGB) o 4 porte (HUB-A ARGB) x connettore a 3 pin 5V della ventola
- 6 porte (HUB-B ARGB) o 4 porte (HUB-A ARGB) x connettore a 3 pin normale della ventola
- 2 porta x connettore a 3 pin dello strip LED
- 1 porta x PWM (HUB-B ARGB)
- 1 porta x collegare 3 pin 5V verso scheda madre
- 1 porta x collegare SATA all'alimentazione
- 1 porta x collegare a 2 pin verso interruttore LED

Funzione:

1. Controllo manuale premendo il pulsante LED
2. Premere il pulsante LED per 3 secondi per cambiare modalità al controllo da scheda madre
3. Premere il pulsante LED per 5 secondi per spegnere l'alimentazione LED
4. Premere il pulsante LED per tornare al controllo manuale tramite il pulsante LED
5. Supporto PWM (HUB-B ARGB)
6. Fino a 6 pz (HUB-B ARGB) o 4 pz (HUB-A ARGB) della ventola ARGB, 2 pz dello strip LED da collegare
7. Con funzione di memoria
8. Effetto casuale al primo avvio

Come usare il controllo manuale:

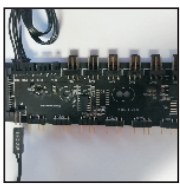

PASSAGGIO 1
Collegare l'interruttore/LED di reset al connettore a 2 pin.

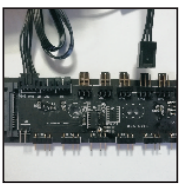

PASSAGGIO 2
Collegare la ventola normale a 3 pin al connettore normale ventola.

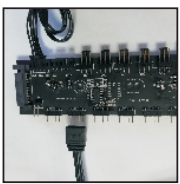

PASSAGGIO 3
Collegare il 3 pin 5V al connettore a 3 pin 5V.

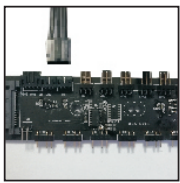

PASSAGGIO 4
Collegare lo strip ARGB a 3 pin al connettore LED.

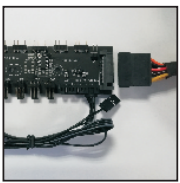

PASSAGGIO 5
Collegare il connettore SATA.



PASSAGGIO 6
Avviare il controllo manuale premendo il pulsante Reset/LED.

Come usare l'adattatore AURA per controllare da scheda madre:



PASSAGGIO 1
Accertarsi che la scheda madre abbia un'installazione RGB indirizzabile 5V.



PASSAGGIO 2
dividare l'adattatore AURA sull'hub ARGB.



PASSAGGIO 3
Collegare l'adattatore AURA (3 pin indirizzabile 5V) dall'hub all'installazione RGB indirizzabile 5V dalla scheda madre.

PASSAGGIO 4

Scaricare il software AURA dal sito ufficiale della scheda madre e installalo sul computer (verificare di aver già installato il software AURA sul computer prima di collegare l'adattatore AURA all'installazione RGB indirizzabile a 5V dalla scheda madre, quindi attivare il sistema AURA. C'è un indicatore di attivazione nell'angolo in alto a sinistra o in altra posizione, dipende dal tipo di scheda madre).

PASSAGGIO 5

Premere il pulsante manuale sul pannello frontale per 3 secondi per passare al controllo da scheda madre; premere il pulsante manuale per 1 secondo per tornare al controllo manuale.

PASSAGGIO 6

Scegliere i diversi effetti colori dal sistema AURA dopo averlo impostato sulla modalità di controllo da scheda madre.

ARGB Hub-A :

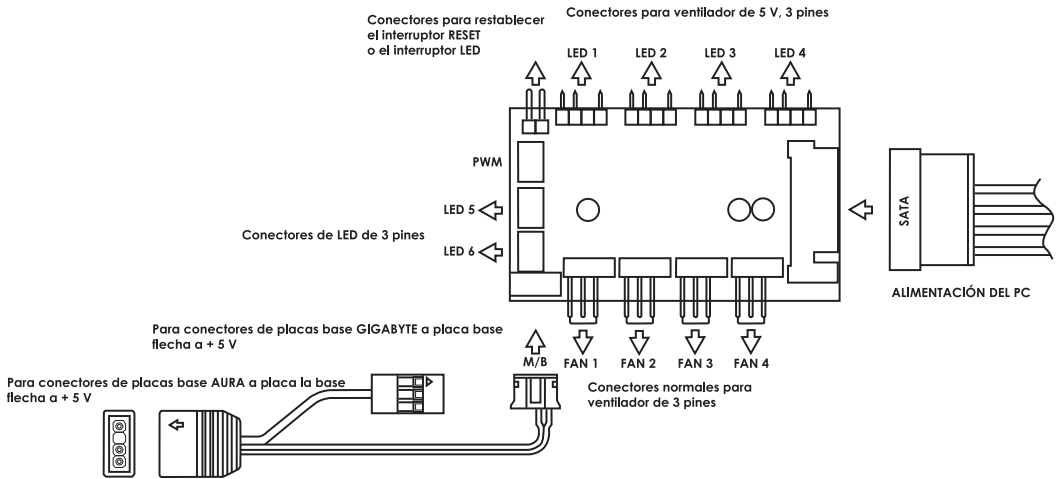

ARGB Hub-B :

Para conectores de placas base al PWM del VENTILADOR (opcional)

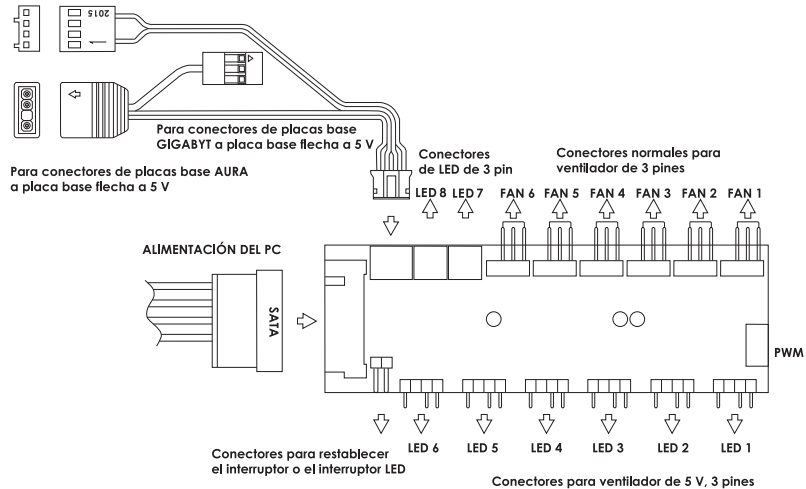

Especificación

Conector de ventilador de 5 V, 3 pines y 6 puertos (HUB-B ARGB) o 4 puertos (HUB-A ARGB)

Conector normal para ventilador de 3 pines y 6 puertos (HUB-B ARGB) o 4 puertos (HUB-A ARGB)

Conector de 2 puertos y 3 pines de tira de luces LED

PWM de 1 puerto (ARGB HUB-B)

Conector a placa base de 5 V, 3 pines y 1 puerto

Conector SATA a fuente de alimentación de 1 puerto

Conector a interruptor de LED de 1 puerto y 2 pines

Función:

1. Control manual pulsando el botón LED
2. Pulsar el botón LED durante 3 segundos para cambiar al modo de control de placa base
3. Pulsar el botón LED durante 5 segundos para interrumpir la alimentación de LED
4. Pulsar el botón LED para recuperar el control manual mediante el botón LED
5. Admite PWM (ARGB HUB-B)
6. Hasta 6 pzs (ARGB HUB-B) o 4 pzs (ARGB HUB-A) de ventilador ARGB, 2 pzs de tira de luces LED a conectar
7. Con función de memoria
8. Efecto aleatorio desde el primer inicio

Cómo utilizar el control manual:

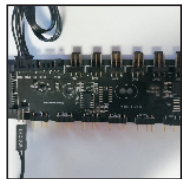

PASO 1

Conecte el interruptor de reinicio/interruptor LED al conector de 2 pines.

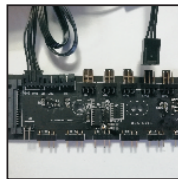

PASO 2

Conecte el ventilador normal de 3 pines al conector de ventilador normal.

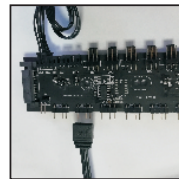

PASO 3

Conecte el conector de 5 V y 3 pines al conector de 5 V y 3 pines.

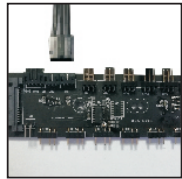

PASO 4

Conecte la tira ARGB de 3 pines al conector LED.

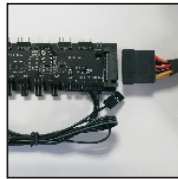

PASO 5

Conecte el conector SATA.



PASO 6

Inicie el control manual pulsando el botón Reiniciar/LED.

Cómo utilizar el adaptador AURA para control por placa base:



PASO 1

Asegúrese de que la placa base tiene una cabecera direccionable RGB de 5 V.



PASO 2

Localice el adaptador AURA del hub ARGB.



PASO 3

Conecte el adaptador AURA (5 V, 3 pines direccionable) del hub a la cabecera direccionable RGB de 5 V procedente de la placa base.

PASO 4

Descargue el software de AURA de la página web oficial de la placa base e instálelo en el ordenador (asegúrese de que haber instalado el software de AURA en el ordenador antes de conectar el adaptador AURA a la cabecera RGB direccionable de 5 V de la placa base; luego, active el sistema AURA. En algún lugar de la esquina superior izquierda hay un indicador de activación, depende de la placa base).

PASO 5

Pulse el botón manual del panel frontal durante 3 segundos para cambiar al modo de control de placa base y pulse el botón durante 1 segundo para recuperar el control manual.

PASO 6

Elija distintos efectos de colores del sistema AURA después de haberlo cambiado al modo de control de placa base.



SPIRIT OF GAMER