



SPIRIT OF GAMER

# FIGHTER SERIES

WE ARE GAMERS



eSports Gaming Gear

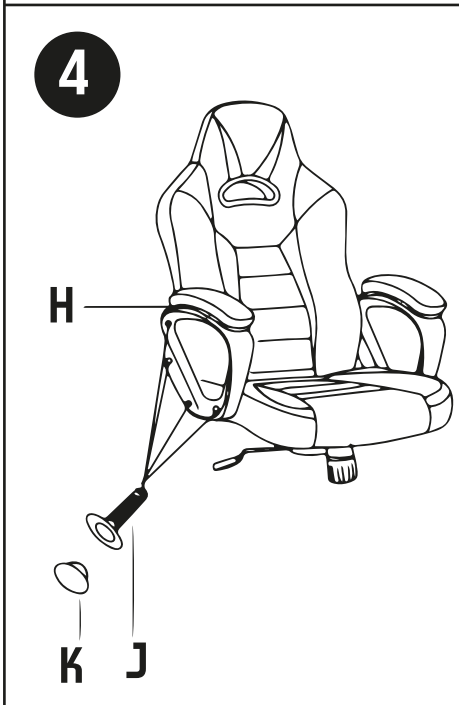
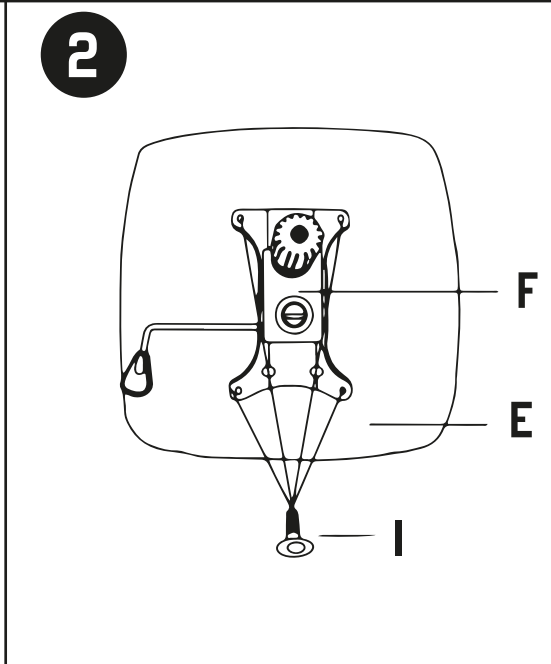
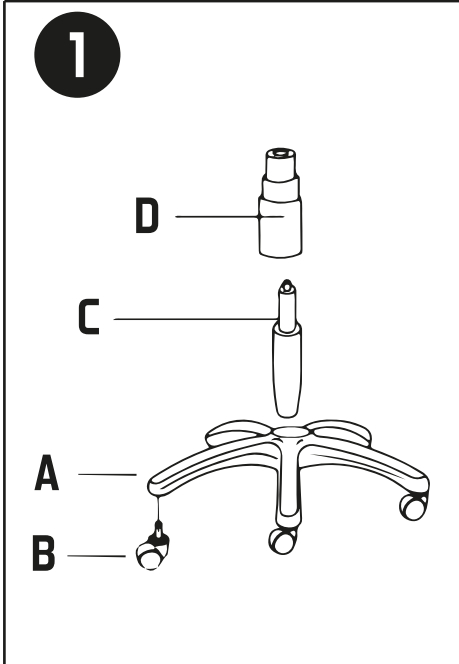





A		1 PC
B		5 PCS
C		1 PC
D		1 PC
E		1 PC
F		1 PC
G		1 PC
H		2 PCS
I	M6 x 20 mm	4 PCS
J	M8 x 25 mm	8 PCS
K		8 PCS
L		1 PC

# WARNINGS

-  Precautions and safety instructions: Do not attempt to disassemble, open, repair or modify the product, accessories or power cable! Risk of injury, electric shock ... Do not expose to moisture, liquids, cold or heat. [...] <http://www.spiritofgamer.com/warnings/>
-  Précautions et instructions de sécurité : Ne tentez pas de démonter, d'ouvrir, de réparer ou de modifier le produit, les accessoires ou le câble d'alimentation ! Risques de blessure, électrocution. ... Ne pas exposer à l'humidité, à des liquides, au froid ou à la chaleur. [...] <http://www.spiritofgamer.com/warnings/>
-  Voorzorgsmaatregelen en veiligheidsinstructies: Probeer niet te demonteren, te openen, te repareren of aan te passen van het product, de accessoires of stroomkabel! Risico op letsel, elektrische schokken ... Niet blootstellen aan vocht, vloeistoffen, koude of warmte. [...] <http://www.spiritofgamer.com/warnings/>
-  Vorsichtsmaßnahmen und Sicherheitshinweise: Versuchen Sie nicht, offen, Reparatur zu zerlegen oder das Produkt, Zubehör oder Stromkabel ändern! Verletzungsgefahr ... Stromschlag ... nicht gegen Feuchtigkeit, Flüssigkeiten, Kälte oder Hitze aus. [...] <http://www.spiritofgamer.com/warnings/>
-  Precauções e instruções de segurança: Não tente desmontar, abrir, reparar ou modificar o produto, acessórios ou cabo de alimentação! Risco de ferimentos, choque elétrico ... Não exponha à humidade, líquidos, frio ou calor. [...] <http://www.spiritofgamer.com/warnings/>
-  Precauciones e instrucciones de seguridad: ¡No intente desmontar, abrir, reparar o modificar el producto, los accesorios o el cable de alimentación! Riesgo de lesiones, descargas eléctricas ... No exponer a humedad, líquidos, frío o calor. [...] <http://www.spiritofgamer.com/warnings/>
-  Precauzioni e avvertenze di sicurezza: Non tentare di smontare, aprire, riparare o modificare il prodotto, sugli accessori o cavo di alimentazione! Pericolo di lesioni, scosse elettriche ... Non esporre a umidità, liquidi, freddo o caldo. [...] <http://www.spiritofgamer.com/warnings/>
-  Profyláxisis kai tis odigias asfaleias: Min epicheirísete na aposynarmologísete, anoíchtó, episkevís i tropopolísis tou próiontos, ta exartimáta i to kalódiá rvmátosis! Kínunos travmatísmou, illektroplíxias ... Min ekthésete se ygrasia, ygrá, kríno i zéstó, [...] <http://www.spiritofgamer.com/warnings/>
-  Meru predostorozhnosti i instrukcii po tehnikke bezopasnosti: Ne pytaýtes' razobrat', otrýut', otremonirovat' ili modifitsirovat' produkt, aksesuary ili kábel' pitaníyá! Opasnost' travmírovaniya, porazheniya elektricheskim tokom ... Ne podvergáite vozdeystvíyu vlági, zhidkostey, kholoda ili tepla. [...] <http://www.spiritofgamer.com/warnings/>
-  Środki ostrożności i instrukcje dotyczące bezpieczeństwa: Nie wolno demontować, otwierać, naprawiać ani modyfikować produktu, akcesoriów ani kabla zasilającego! Niebezpieczeństwo odniesienia obrażeń, porażenia prądem elektrycznym ... Nie wystawiać na działanie wilgoci, cieczy, zimna lub ciepła. [...] <http://www.spiritofgamer.com/warnings/>
-  Măsurile de precauție și instrucțiunile de siguranță: Nu încercați să demontați, deschiși, reparați sau modificați produsul, accesoriul sau cablu de alimentare! Risc de rănire, electrocutare ... Nu expuneți la umiditate, lichide, frig sau căldură. [...] <http://www.spiritofgamer.com/warnings/>
-  Óvintézkedések és biztonsági utasítások: Ne próbálja meg szétszerelni, nyitni, javítsa vagy módosítsa a készüléket, tartozékokat vagy tápkábel! A sérülés veszélye, áramütés ... ne tegye ki nedvesség, folyadék, hideg vagy meleg. [...] <http://www.spiritofgamer.com/warnings/>
-  Mjere opreza i sigurnosne upute: Ne pokušavajte rastavljati, otvarati, popravak ili modificirati proizvod, pribor ili kábel za napajanje! Opasnost od ozljeđe, strujnog udara ... Ne izlagati vlaži, tekućine, hladno ili toplinu. [...] <http://www.spiritofgamer.com/warnings/>
-  Bezpečnostní opatření a bezpečnostní pokyny: Nepokoušejte se rozebírat, otevírat, opravit nebo upravit výrobku, jeho příslušenství nebo napájecího kabelu! Nebezpečí úrazu elektrickým proudem ... Nevystavujte vlhkosti, kapalinám, chladu nebo tepla. [...] <http://www.spiritofgamer.com/warnings/>















# WARRANTY

-  Warranty: The warranty of this device is available online! <http://www.spiritofgamer.com/warranty/>
-  Garantie : La garantie de cet appareil est consultable en ligne ! <http://www.spiritofgamer.com/warranty/>
-  Garantie: de garantie van dit apparaat is online beschikbaar! <http://www.spiritofgamer.com/warranty/>
-  Garantie: Die Garantie dieses Gerätes ist online verfügbar! <http://www.spiritofgamer.com/warranty/>
-  Garantia: a garanția deste dispozitiv este disponibil online! <http://www.spiritofgamer.com/warranty/>
-  Garantia: la garantía de este dispositivo está disponible en línea! <http://www.spiritofgamer.com/warranty/>
-  Garanzia: la garanzia di questo dispositivo è disponibile on-line! <http://www.spiritofgamer.com/warranty/>
-  Engýjisi: i engýjisi tis syskevis aftis einai diathésima sto diadiktýio! <http://www.spiritofgamer.com/warranty/>
-  Garanțiya: garanțiya na eto ustroystvo dostupna v Internetel! <http://www.spiritofgamer.com/warranty/>
-  Gwarancja: gwarancja tego urządzenia jest dostępna online! <http://www.spiritofgamer.com/warranty/>
-  Garantie: garanția acestui dispozitiv este disponibil on-line! <http://www.spiritofgamer.com/warranty/>
-  Garancia: A garancia a készülék elérhető online! <http://www.spiritofgamer.com/warranty/>
-  Jamstvo: jamstvo za ovaj uređaj je dostupan online! <http://www.spiritofgamer.com/warranty/>
-  Záruka: záruka tohoto zařízení je k dispozici on-line! <http://www.spiritofgamer.com/warranty/>

# DOWNLOAD CENTER

-  Download Center: Download drivers, advanced manuals ... <http://www.spiritofgamer.com/downloadcenter/>
-  Centre de Téléchargement : Télécharger en ligne les drivers, manuels avancés. ... <http://www.spiritofgamer.com/downloadcenter/>
-  Downloadcentrum: download stuurprogramma's, geavanceerde handleidingen ... <http://www.spiritofgamer.com/downloadcenter/>
-  Download-Center: Download-Treiber, erweiterte Handbücher ... <http://www.spiritofgamer.com/downloadcenter/>
-  Downlod center: download de drivers, manuais avançados ... <http://www.spiritofgamer.com/downloadcenter/>
-  Descargar centro: descargar controladores, manuales avanzados ... <http://www.spiritofgamer.com/downloadcenter/>
-  Centro di download: scaricare driver, manuali avanzati ... <http://www.spiritofgamer.com/downloadcenter/>
-  Downlod center: lípsi programmáton odígisis, prográmnes encheirída ... <http://www.spiritofgamer.com/downloadcenter/>
-  Tsentr zagruzki: skachat' drayvery, rashirennyye rukovodstva ... <http://www.spiritofgamer.com/downloadcenter/>
-  Centrum pobierania: sterowniki pobierania, zaawansowane instrukcje ... <http://www.spiritofgamer.com/downloadcenter/>
-  Centrul de descărcare: Descărcare drivere, manuale avansate ... <http://www.spiritofgamer.com/downloadcenter/>
-  letöltési központ: letöltés vezetők, a fejlett kézikönyvek ... <http://www.spiritofgamer.com/downloadcenter/>
-  centar za preuzimanje: preuzimanje upravljačkih programa, napredni priručnici ... <http://www.spiritofgamer.com/downloadcenter/>
-  Stažení: Stažení ovladačů, pokročilé manuály ... <http://www.spiritofgamer.com/downloadcenter/>















# SUPPORT TEAM

-  Support: Need help? Our Gamers technicians are there for you! Online support: <http://www.spiritofgamer.com/support/>
-  Support technique : Besoin d'aide ? Nos techniciens Gamers sont là pour vous ! Assistance en ligne : <http://www.spiritofgamer.com/support/>
-  Ondersteuning: Hulp nodig? Gamers Onze technici zijn er voor u! Online media: <http://www.spiritofgamer.com/support/>
-  Support: Hilfe nötig? Gamers Unsere Techniker sind für Sie da! Online-Medien: <http://www.spiritofgamer.com/support/>
-  Apoio: Precisa de ajuda? Os jogadores Nossos técnicos estão lá para você! Mídia on-line: <http://www.spiritofgamer.com/support/>
-  Soporte: ¿Necesita ayuda? Los jugadores Nuestros técnicos están a su disposición! Los medios de comunicación en línea: <http://www.spiritofgamer.com/support/>
-  Supporto: Bisogno d'aiuto? I giocatori I nostri tecnici sono a vostra disposizione! Media Online: <http://www.spiritofgamer.com/support/>
-  Ypostírxi: Chreiazeste voitheia? Oi paiktes techníki mas einai ekei gia sas! Online Media: <http://www.spiritofgamer.com/support/>
-  Podderzhka: Nuzhna pomoshch? Geymery Nashi spetsialisty tam dlya vas! Internet SMI: <http://www.spiritofgamer.com/support/>
-  Pomoc: Potrzebujesz pomocy? Grazie Nasi technicy są do Państwa dyspozycji! W mediach online: <http://www.spiritofgamer.com/support/>
-  Support: Aveți nevoie de ajutor? Jucătorii tehnicienii noștri sunt acolo pentru tine! Media online: <http://www.spiritofgamer.com/support/>
-  Support: Segitségre van szükségé? A játékosok Szakembereink vannak az Ön számára! Online média: <http://www.spiritofgamer.com/support/>
-  Podrška: Trebate pomoć? Igrači Naši tehničari su tu za vas! Online mediji: <http://www.spiritofgamer.com/support/>
-  Podpora: Potřebujete pomoc? Hráči Naši technici jsou tu pro vás! Online média: <http://www.spiritofgamer.com/support/>

# WEEE

-  Environmental protection: WEEE (Waste Electrical and Electronic Equipment): Place this device in a recycling center: Thank you!
-  Protection de l'environnement : WEEE (Waste Electrical and Electronic Equipment) : Déposez cet appareil dans un centre de recyclage : Merci !
-  Bescherming van het milieu: WEEE (Waste Electrical and Electronic Equipment): Plaats dit apparaat in een recycling centrum: Dank je wel!
-  Umweltschutz: WEEE (Elektro- und Elektronik-Altgeräte): Legen Sie dieses Gerät in ein Recycling-Center: Vielen Dank!
-  Protecção ambiental: WEEE (Resíduos de equipamentos eléctricos e electrónicos): Coloque este dispositivo num centro de reciclagem: Obrigado!
-  Protección del medio ambiente: WEEE (Residuos de aparatos eléctricos y electrónicos): Coloque este dispositivo en un centro de reciclaje: ¡Gracias!
-  Protezione dell'ambiente: WEEE (Waste Electrical and Electronic Equipment): Posizionare il dispositivo in un centro di riciclaggio: Grazie!
-  Tin prostasia tou perivállontos: ta AIEE (Apóvlika Illektríkoú kai Illektroníkoú Exapllísmou): thési afti i syskevi se éna kéntro anakýklósis: sas efcharisto!
-  Zashchita okruzhayushchey sredy: WEEE (utilizatsiya elektricheskogo i elektronnoho obrudovaniya): pomestite eto ustroystvo v tsentr utilizatsii: spasibo!
-  Ochrona środowiska: WEEE (zużyty sprzęt elektryczny i elektroniczny): umieść to urządzenie w centrum recyklingu: dziękuję!
-  Protecția mediului: DEEE (Deșeurile de echipamente electrice și electronice): acest dispozitiv lui într-un centru de reciclare: vă mulțumesc!
-  Környezetvédelem: WEEE (Waste Electrical and Electronic Equipment): hely ez a készülék egy újrahasznosító központban: köszönm!
-  Zaštita okoliša: WEEE (Otpad električne i elektroničke opreme): mjesto je ovaj uređaj u reciklažnom centru: hvala!
-  Ochrana životního prostředí: WEEE (o odpadních elektrických a elektronických zařízeních): místo toto zařízení do recyklačního centra: Děkuji!

# LEGAL INFORMATION

-  Legal information and compliance: Spirit of Gamer declares that this device complies with the essential requirements and other relevant provisions of Directive 1999/5 / EU.
-  Informations légales et conformité: Spirit of Gamer déclare que cet appareil est conforme aux exigences essentielles et aux autres dispositions concernées par la directive 1999/5 / EU.
-  Juridische informatie en compliance: Spirit of Gamer verklaart dat dit apparaat voldoet aan de essentiële eisen en andere relevante bepalingen van richtlijn 1999/5 / EU.
-  Rechtliche Hinweise und Nachgiebigkeit: Spirit of Gamer erklärt, dass dieses Gerät die grundlegenden Anforderungen und sonstigen einschlägigen Bestimmungen der Richtlinie 1999/5 / EU erfüllt.
-  Informações legais e conformidade: A Spirit of Gamer declara que este dispositivo está em conformidade com os requisitos essenciais e outras disposições relevantes da Directiva 1999/5 / EU.
-  Información legal y cumplimiento: Spirit of Gamer declara que este dispositivo cumple con los requisitos esenciales y otras disposiciones pertinentes de la Directiva 1999/5 / EU.
-  Informazioni legali e di conformità: Spirit of Gamer dichiara che questo dispositivo è conforme ai requisiti essenziali e alle altre disposizioni pertinenti della direttiva 1999/5 / EU.
-  Νομικές πληροφορίες και συμμόρφωση: Spirit of Gamer δηλώνει ότι αυτό i συσκευή συμμορφώνεται με τις ουσιαστικές απαιτήσεις και τις λοιπές σχετικές διατάξεις της οδηγίας 1999/5 / EU.
-  Yuridicheskaya informatsiya i sootvetstviye trebovaniyam: Spirit of Gamer zavayvlyayet, chto dannoye ustroystvo sootvetstvuyet osnovnym trebovaniyam i drugim sootvetstvuyushchim položeniyam Direktivy 1999/5 / EU.
-  Informacje prawne i zgodność: Spirit of Gamer oświadcza, że to urządzenie spełnia podstawowe wymogi i inne stosowne przepisy dyrektywy 1999/5 / UE.
-  Informații legale și conformitate: Spirit of Gamer declară că acest dispozitiv este în conformitate cu cerințele esențiale și alte prevederi relevante ale Directivei 1999/5 / UE.
-  Jogi információk és megfelelés: Spirit of Gamer kijelenti, hogy ez a készülék megfelel az alapvető követelményeknek és egyéb vonatkozó rendelkezéseinek 1999/5 irányelv / EU.
-  Právne informácie a uskladenost: Spirit of Gamer izjavljuje da je ovaj uređaj usklađen s ključnim zahtjevima i drugim važnim odredbama direktive 1999/5 / EU.
-  Právní informace a dodržování: Spirit of Gamer prohlašuje, že toto zařízení je v souladu se základními požadavky a dalšími příslušnými ustanoveními směrnice 1999/5 / EU.